

- 10' wide, 8' tall back wall with monitor mount

- 2'x7' counter

- 18"x18" podium

- Virtually tool-free assembly - all you need are a few allen wrenches

- Finished dimensions 120" w X 120" d X 95" h

Please Note: Assembly and graphics installation will require the use of a ladder or tall step stool.

STOP - PLEASE READ:

Before you start frame assembly or installing the fabric/graphic,













PLEASE READ AND FOLLOW ALL INSTRUCTIONS.

When installed correctly, the Panoramic System fabric will not sag or appear out of alignment.

Frame pieces are color coded.
Colors correspond to Floor Plan
and Frame Detail drawings.

Additional frame markings may
be used when necessary.

12 basic colors:

- RED 
- GRN 
- ORG 
- BLUE 
- PURP 
- DARK GRN 
- TAN 
- PINK 
- YEL 
- WHT 
- DARK BLUE 
- GRAY 

4 types of inserts:

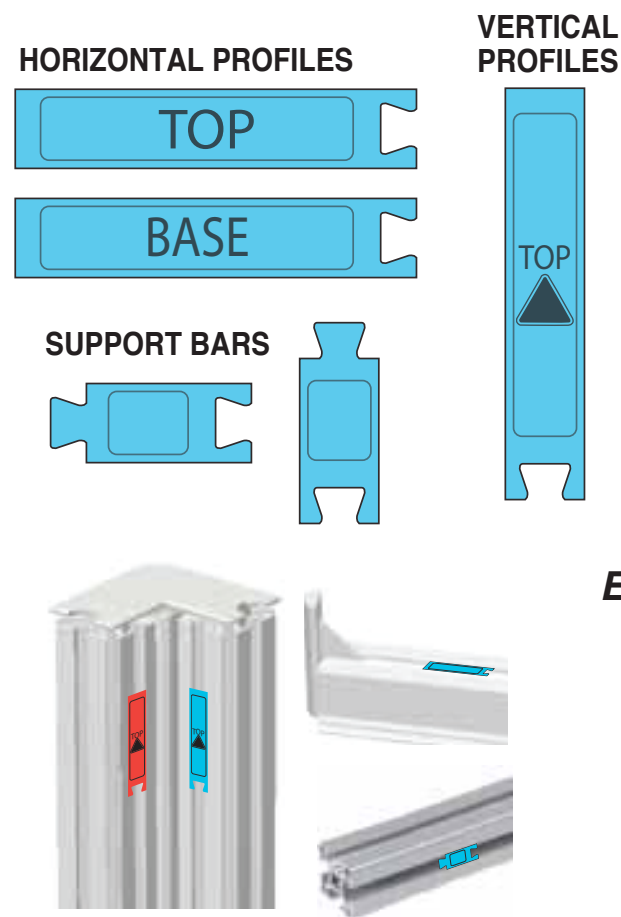

For additional labeling needs,
a combination of 2 different
colored labels is used.

In most cases, color identification is the
only labeling necessary - suplimental
labeling may be used when needed.

NOTE: Frame and graphics shown here are for illustration purposes only. Refer to the customized Frame Assembly and Graphics Installation Instructions for your particular Panoramic product.

Example:

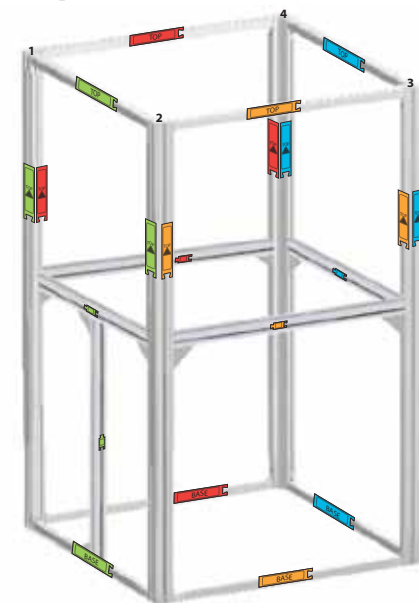

Graphics are identified with a numbered tab in
the upper right corner. Numbers correspond to
graphics templates shown on Graphics page(s).

Silicone welts go into system grooves at 90° angles
as shown below.

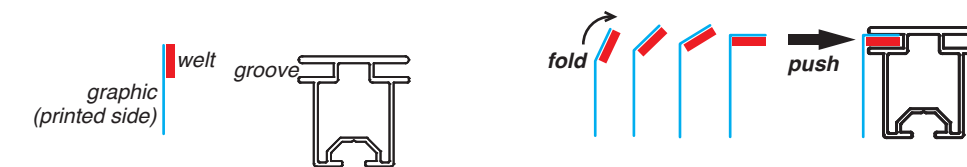







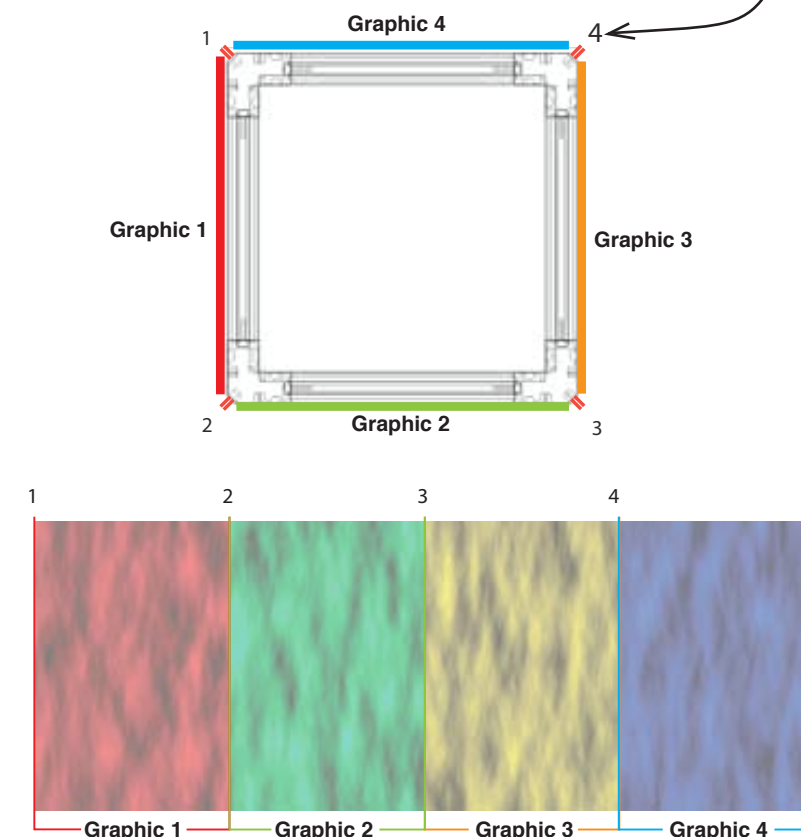



**Accurately follow all instructions on Graphics page(s)
to insure proper installation.**

Graphic assembly instructions and templates follow same
color code order (when possible).

Frames will be numbered at all graphic installation points.



Parts List:

Description		Qty
Pano_L-Frame		2
Pano_C-Frame		8
Pano_I-Frame		2
Pano_F-Frame		24
Support Bar		2
Corner Brace		4
Junction Link		2
Counter Top 26x86		1
Counter Top 22x22		1
Baseplate w Bolt		2
Monitor Mount Kit		1

L - Vertical
2 @ 40.5"

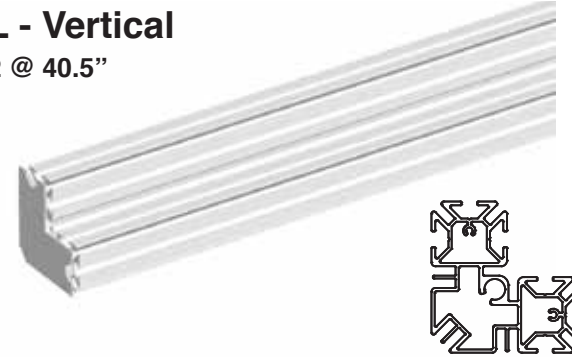

C - Vertical
8 @ 40.5"

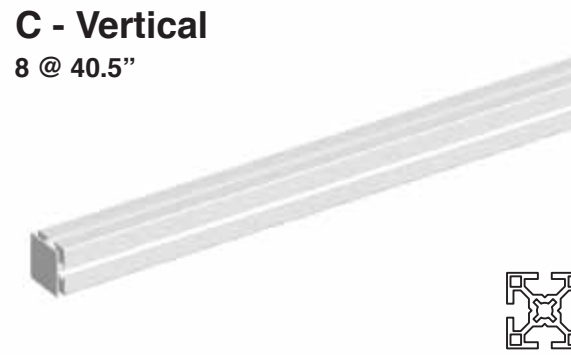

I - Vertical
2 @ 8'

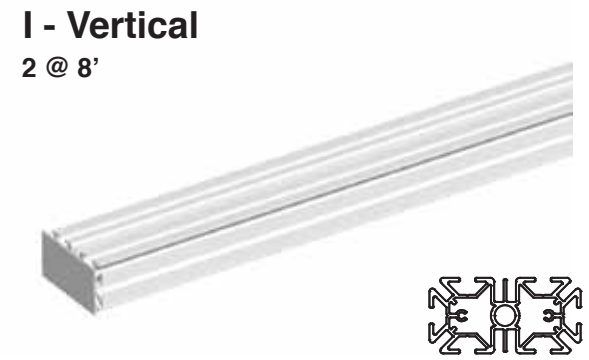

Support Bar
2 pieces

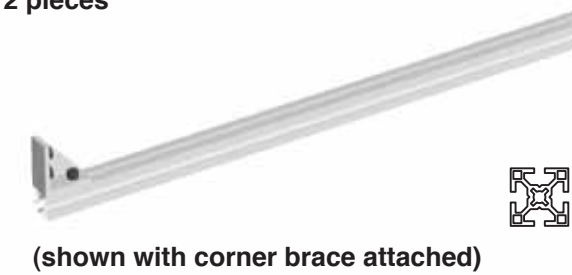

F - Horizontal

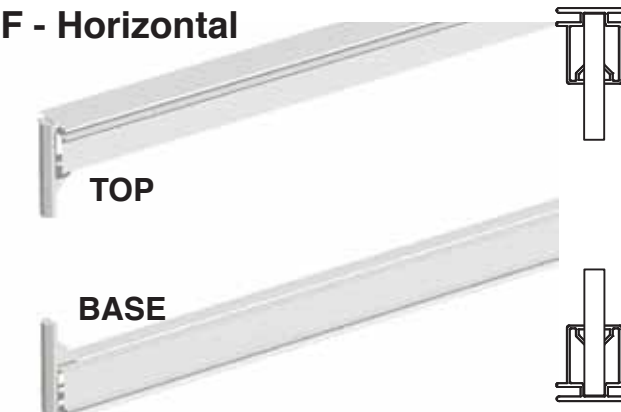

Tools Needed:

For assembly and graphics installation:

- 5mm allen wrench (supplied)
- ladder or tall step stool (not supplied)

1: Arrange the bottom Pano_F horizontal sections in place. See Floor Plan and Frame Detail pages. Corner connectors will already be in place and the sections will be color coded. Bottom horizontal sections will have the word "BASE" printed on their inserts.

2: Use the Junction Links to connect the pieces of horizontal sections for the back wall. See Figure 1.

2: Place the vertical posts down onto the corner connectors on the horizontal sections. Tighten the D screws on the vertical posts. See Figure 2.

3: Slide the top horizontal sections onto the vertical posts. Tighten the D screws on the vertical posts. See Figure 3.

4: Install the support bars. See Figure 4.

5: Install base plate using large bolt. See Figure 5.

6: Install monitor mount kit according to Separate installation instructions.

Fig 1:



Fig 2:

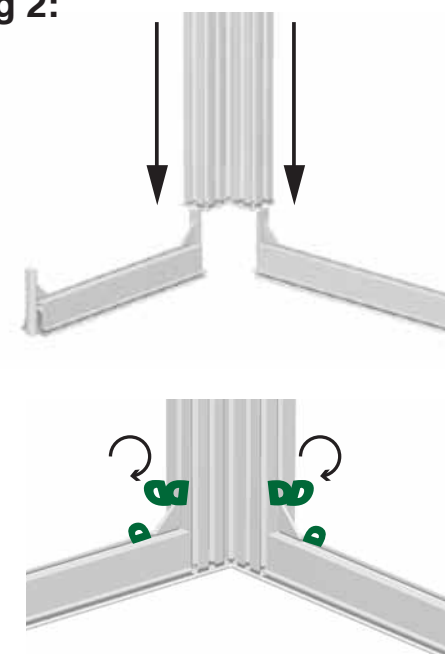

Fig 3:

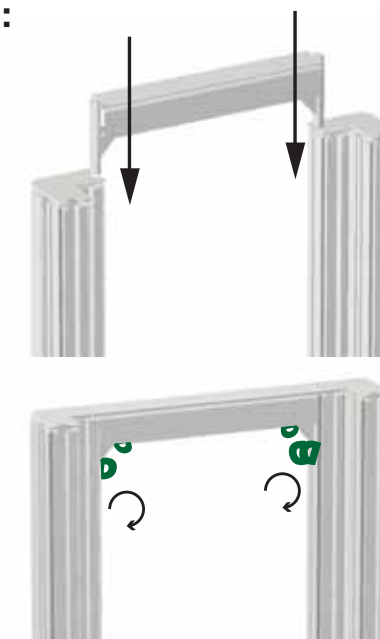

Fig 4:

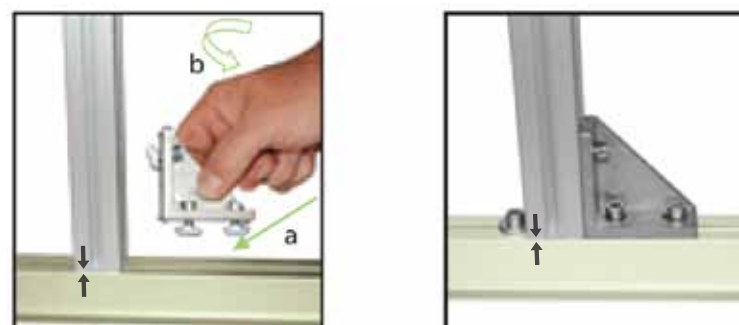
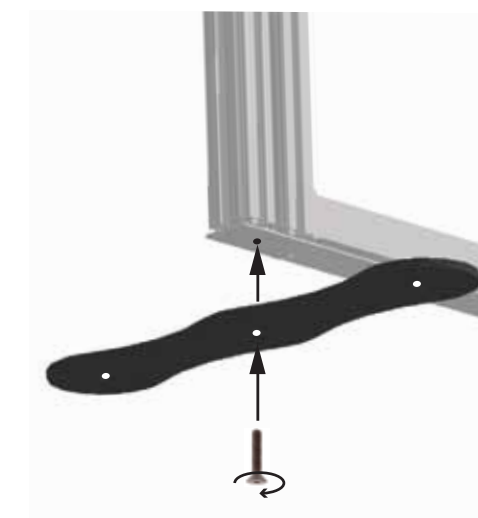

Fig 5:



To dismantle - Loosen D screws on vertical posts only to disassemble. Keep corner connectors attached to horizontals.

Note: Frame pieces are labeled with colored inserts. Graphic installation points are identified with numbers.

Wall

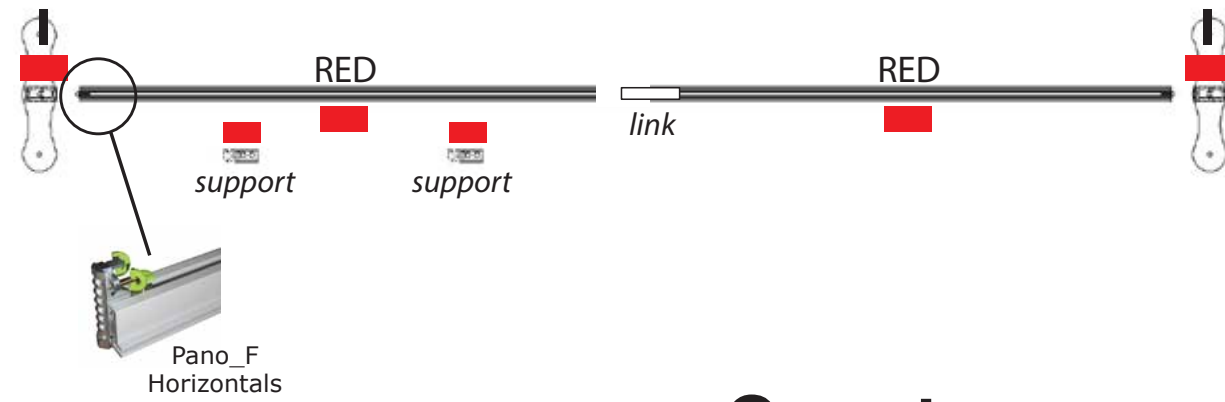

Counter

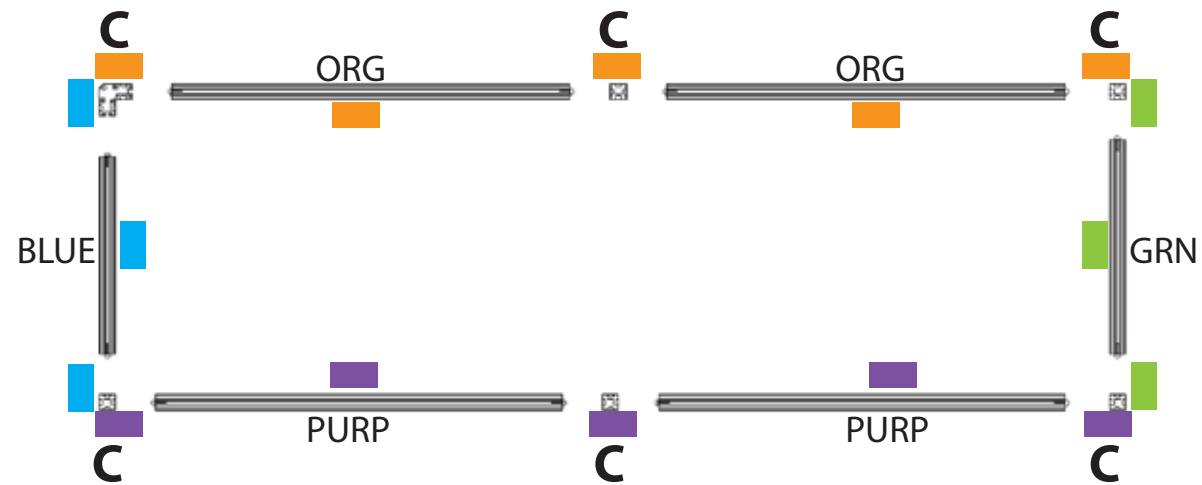

Podium

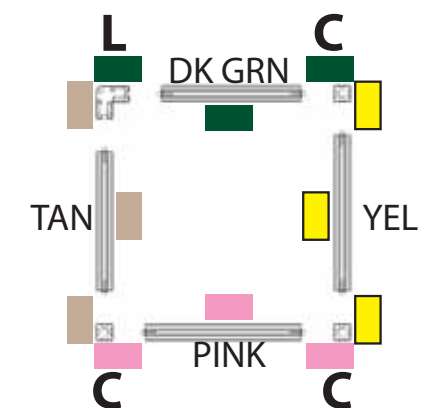

Wall

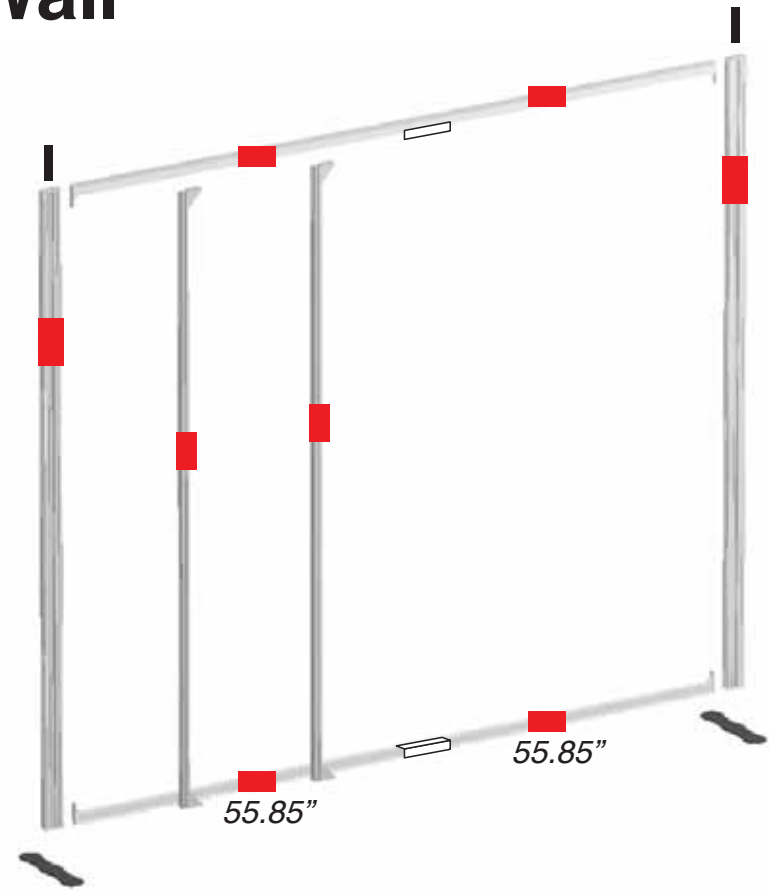

Counter

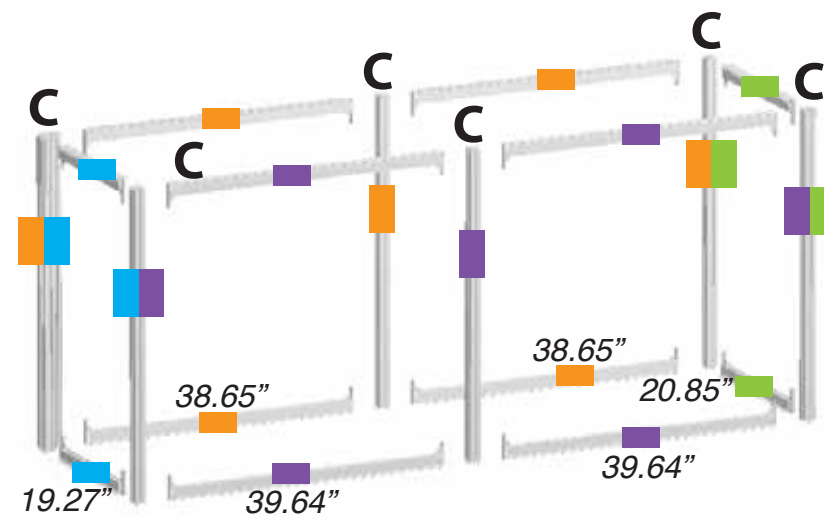

Podium

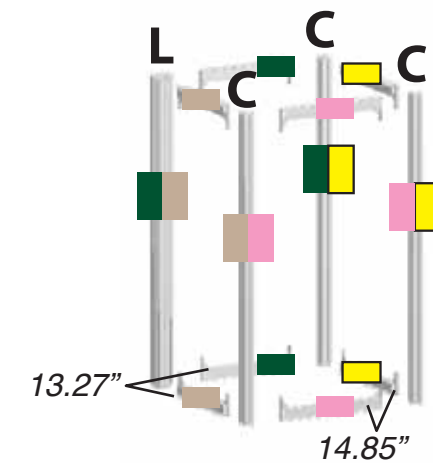

- Position “base” horizontals per diagram
- Place verticals onto horizontals, lock in place
- Add “top” horizontals
- Install supports, base plates

WALL



COUNTER

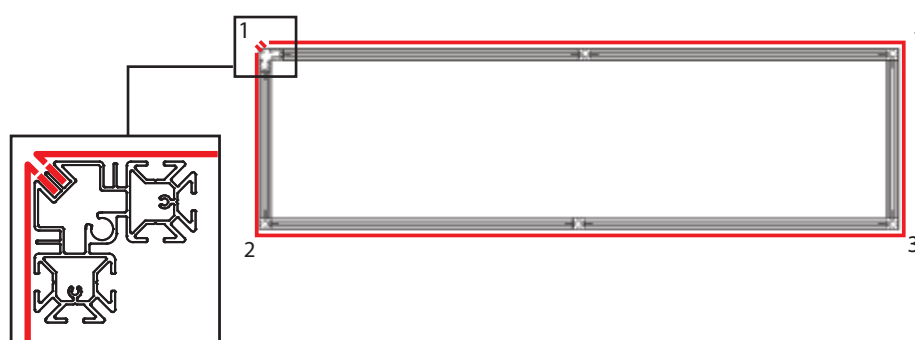

PODIUM

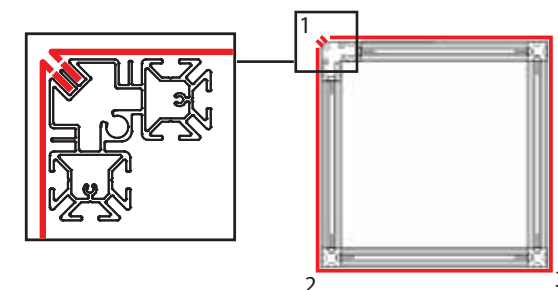

See also: Graphics Map

Note: Frame pieces are labeled with colored inserts. Graphic installation points are identified with numbers.

Before installing the graphics:

- Make sure the work area is clean and free of objects which could mar or snag the graphics
- Wear gloves and/or use other means to keep the fabric from getting soiled.

Proper installation of the graphics requires following these steps, in order.

Install the graphics one at a time. Fully install the graphics completely along their top and sides before doing any of the bottom edges.

Always start at the ends, then do the middles, then work from the middle out to the ends.

Always push the graphics into the grooves, one section at a time - never "slide" the graphics into place.

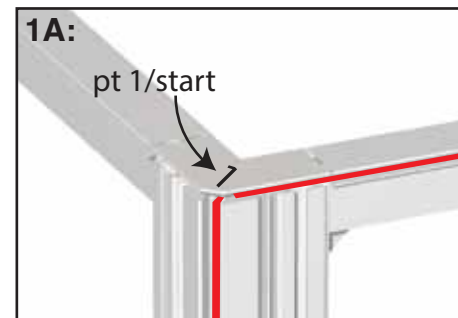

1: Identify start point on top of frame (shown in 1A) and graphic top left corner with start tab (shown in 1B).

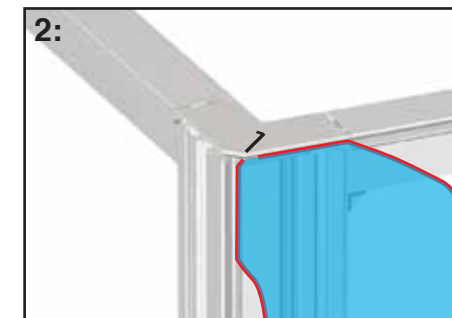
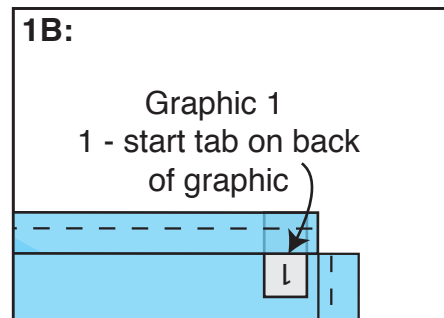

2: Insert top corner of graphic and welt into top groove of vertical at point 1. Align welt on left with vertical groove, insert into groove a few inches.

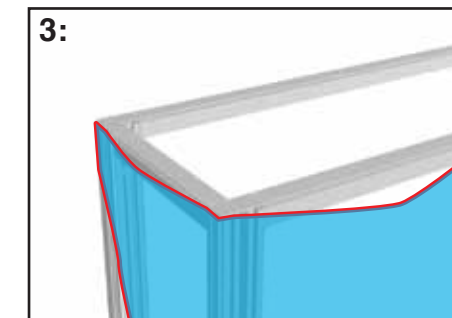

3: Align corners of graphic with corners on frame. Insert top of welt into corners, then insert top right welt a few inches into groove at point 4.
Corners must be done first to assure proper fit.

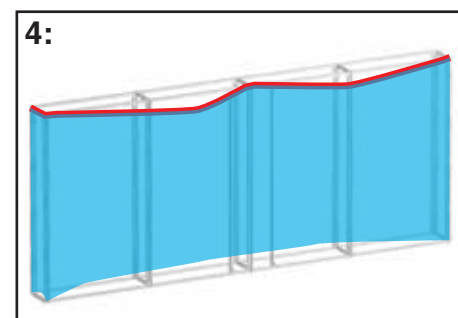

4: Work in top welt between corners from middle out to corners making sure graphic is evenly distributed.
Be sure to push the graphic into the groove, not slide.

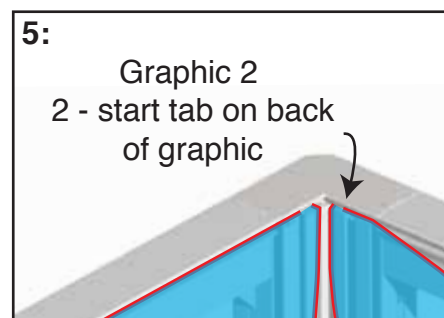

5: For frames with multiple graphics, align the next graphic with the first. Follow steps 1-4 before doing the sides and bottoms.

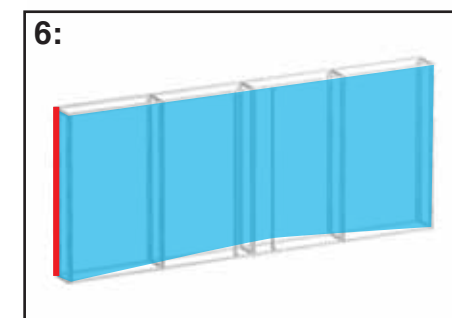

6: Insert welt into vertical grooves between top and bottom corners. Work from middle out, making sure graphic is evenly distributed.

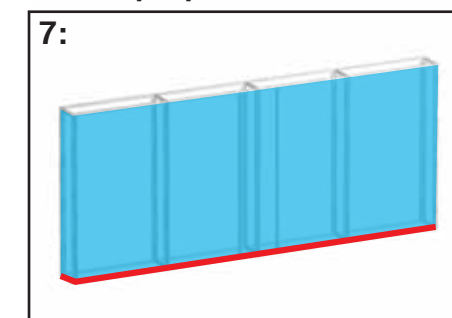

7: Follow steps 1-4 for bottoms of graphics.

WALL



COUNTER

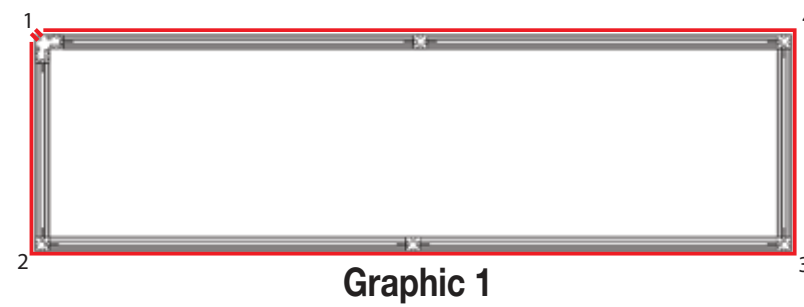

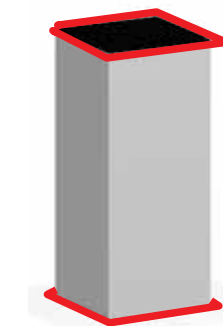
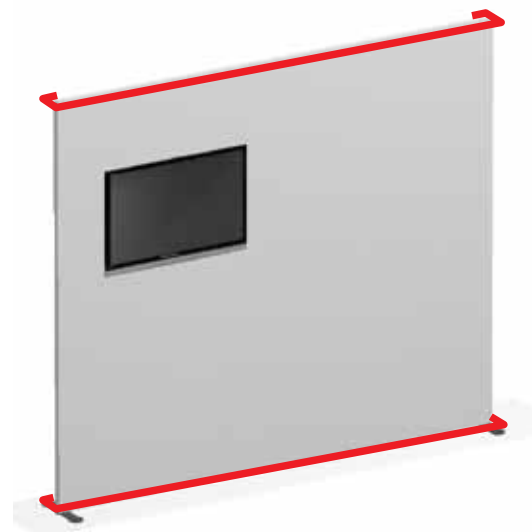
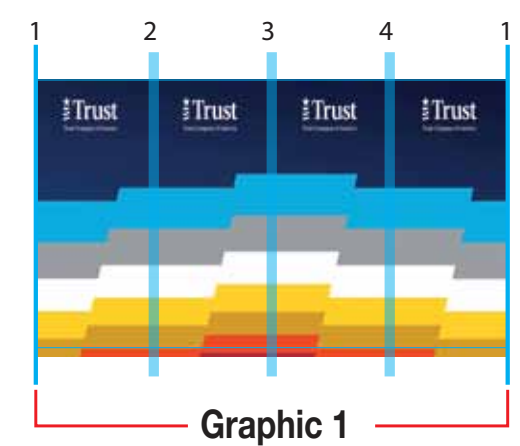
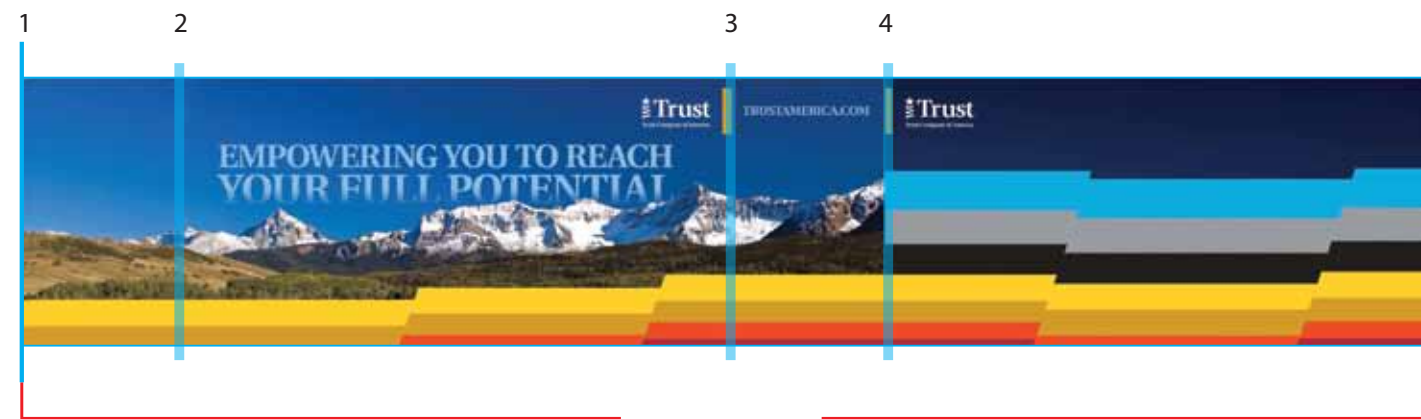
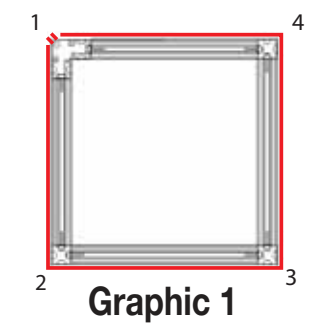

PODIUM



NOTE: Graphics shown are for reference only

Parts List:

Description	Qty each
Large Monitor Mount 	1
Support Bar 	2*
Corner Bracket 	4*
Long Hex Cap screws w T-Nuts	4
Washers	8

1: *The vertical support bars and corner brackets should already be in place. If not, refer to Basics for installation instructions.

NOTE: Install the supports before installing the graphics. Install graphics on the side of the frame that the monitor is attaching to before installing the monitor mount.

2: Level the wall plate and align with the pre-drilled holes in the supports. Thread Hex Cap screws through washers, mount hardware, washers, and supports. T-Nuts on back will seat in the system grooves. See Figure 1.

3: Tighten Hex Cap screws until snug.

4: Install balance of graphics on frame.

5: Follow instructions from monitor mount manufacturer to attach hardware to monitor and then to mount.

Fig 1:

